

# ZERO AND BASE

design by Civic



- Range of LEDtape profiles for interior use
- The extrusion is made in anodised aluminium.
- Available in 2m lengths
- Diffusers Available:
  - Zero
  - Square opal
  - Flat opal

- Base
  - Round opal
  - Wide beam transparent
  - Narrow beam transparent

- Requires open or enclosed LEDtape and accessories (Fig. 1)
- Can be installed on normally flammable surfaces

Fig. 1



# ZERO AND BASE

design by Civic

## ZERO

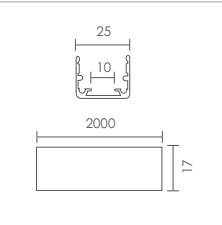
Profile	Dimensions	Code/Description
		1037.1 Surface mount

To be used with LEDtape + accessories

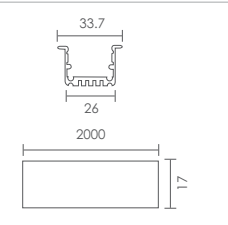
Profile	Dimensions	Code/Description
		1037.2 Recessed

To be used with LEDtape + accessories

Diffuser	Code/Description
	1037.D.1 Flat opal 2000mm

Diffuser	Code/Description
	1037.D.2 Square opal 2000mm

## BASE

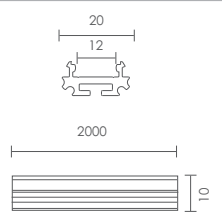
Profile	Dimensions	Code/Description
		1038.1 Base 1

To be used with LEDtape + accessories

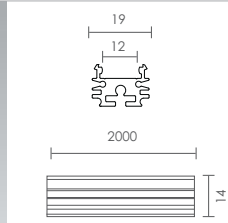
Profile	Dimensions	Code/Description
		1038.2 Base 2

To be used with LEDtape + accessories

Diffuser	Code/Description
	1038.D.1 Round opal 2000mm

Diffuser	Code/Description
	1038.D.2 Wide beam transparent 2000mm

Diffuser	Code/Description
	1038.D.3 Narrow beam transparent 2000mm

Fitting	Code/Description
	1038.CLIP Base 1/2 clip

# ZERO INSTALLATION

design by Civic



Attach the Zero extrusion to required surface

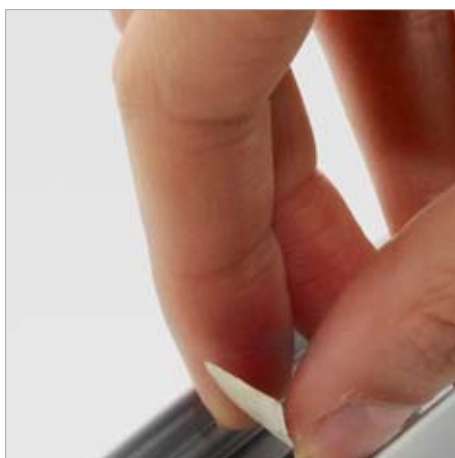

Remove the application tape from LEDtape and apply to Zero surf.



Applied LEDtape



Attach the desired diffuser, Square or Flat opal diffuser available



Zero recessed extrusion



Remove the application tape from LEDtape and apply to Zero Rec.



Applied LEDtape



Slide or attach desired diffuser, Square or Flat opal diffuser available

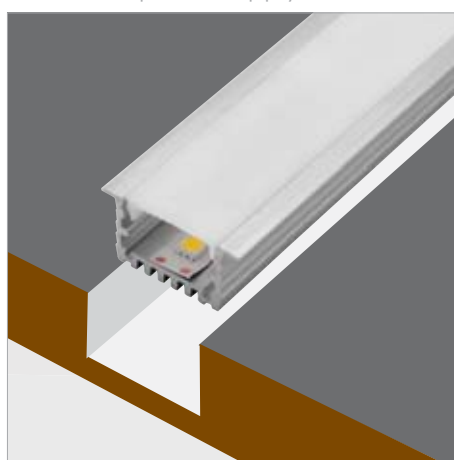

Make the necessary cut out and and install the Zero Recessed

# BASE INSTALLATION

design by Civic



Screw clips to required surface



Clip the base extrusion on by pushing down on the clip/s



Remove the application tape from LEDtape and apply to Base



Applied LEDtape

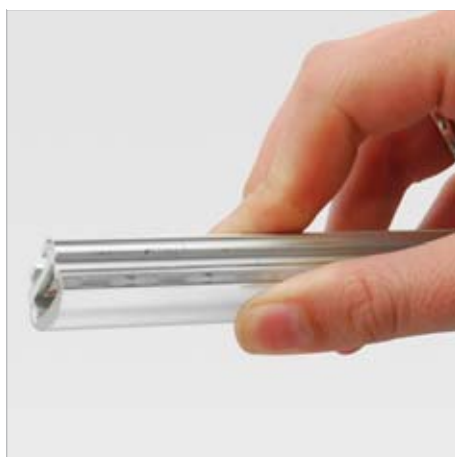

Clip or slide on the required diffuser



Transparent diffuser, Available in wide or narrow beam



Round opal diffuser

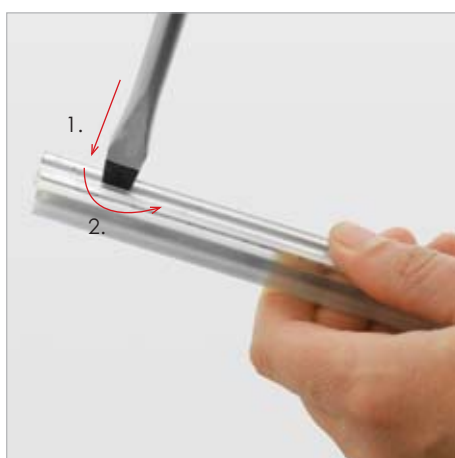

Should you not be able to slide the diffuser off due to the nature of the installation, please use a flat screwdriver as leverage applying steps 1 and 2 at different intervals along the profile